

Mirka Hoses & Adapters

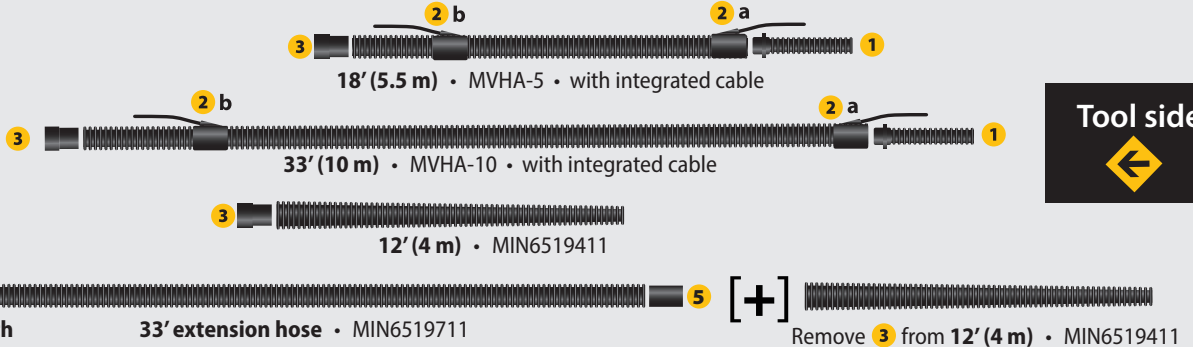

Hoses come with all pieces and connections shown.

Mirka® DEROS



Mirka® PROS / MR

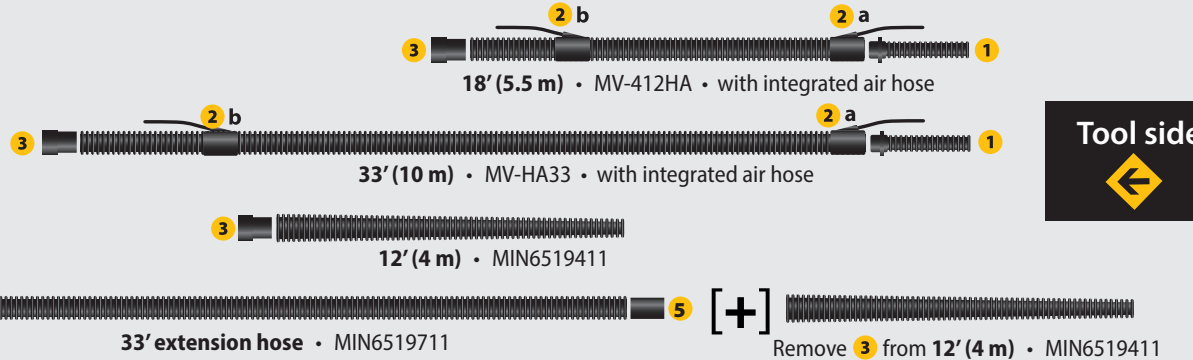

Hand Sanding Blocks

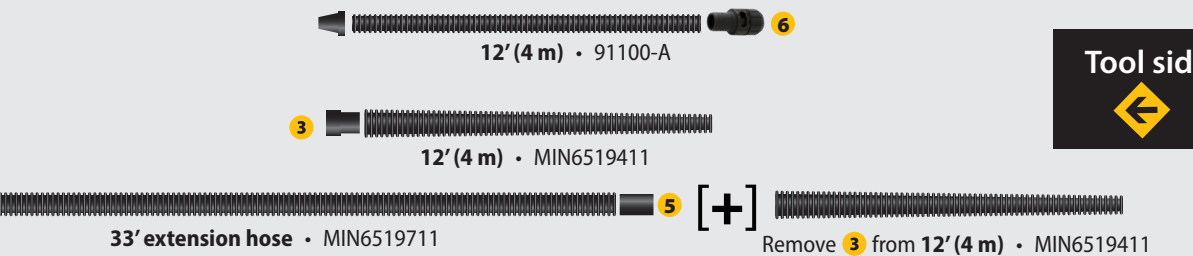

DUST EXTRACTOR & ACCESSORIES



All hoses and adapters work with the Mirka MV-912 dust extractor. Adapters 1-6 can be ordered as spare parts.



Dust Extractor
MV-912



Pneumatic box
MV-912PB
Auto On/Off vacuum control for pneumatic sander



Dual Operator Kit
MV-412DOK
Allows use of two sanders with one MV-912 dust extractor



Filter Element
MV-412FE
Use with MV-912 dust extractor

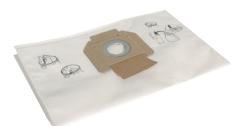

Dust Bag
MV-912DB
Use with MV-912 dust extractor

Mirka Hoses & Adapters

Mirka® DEROS		Ø to Sander (mm)	
Part #	Hose diameters and length	Inner	Outer
MVHA-5	Hose 1-1/2" x 18' • with Integrated Cable	25	27 / 32
MVHA-10	Hose 1-1/2" x 33' • with Integrated Cable	25	27 / 32
MIN6519411	Hose 1-1/2" x 12' + Connector	25	27 / 32
MIN6519711	Extension Hose 1-1/2" x 33'	25	27 / 32

Mirka® PROS / ROS / MR Series		Ø to Sander (mm)	
Part #	Hose diameters and length	Inner	Outer
MV-412HA	Hose 1-1/2" x 15' • with Integrated air hose	25	27 / 32
MV-HA33	Hose 1-1/2" x 33' • with Integrated air hose	25	27 / 32
MIN6519411	Hose 1-1/2" x 12' + Connector	25	27 / 32
MIN6519711	Extension Hose 1-1/2" x 33'	25	27 / 32

Hand Sanding Blocks		Ø to Sander (mm)	
Part #	Hose diameters and length	Inner	Outer
91100-A	Hose 3/4" x 12' + Connector	20	22 / 26
MIN6519411	Tapered Hose 1-1/2" to 1-1/4" x 12' + Connector	22	27 / 32
MIN6519711	Extension Hose 1-1/2" x 33'	25	27 / 32

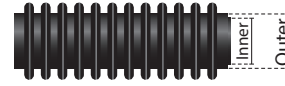

MVHA-5 (18') • MVHA-10 (33')



MV-412HA (15') • MV-HA33 (33')









91100-A



MIN6519411

➔ All hoses and adapters work with the Mirka MV-912 dust extractor. Adapters 1–6 can be ordered as spare parts.

Adapter	Description
 MV-412HA-ADAP	1 Hose 1-1/2" x 15' + Connector. This conductive adapter enables a quick change in-between Mirka power tools. Fix the adapter on each tool and connect/disconnect to/from any Mirka hose assembly with a Mirka branded adapter, both pneumatic: MV-412HA, MV-HA33, and electric: MVHA-5 and MVHA-10.
 VHA-1.25	2 a Mirka Connector for Air + Electric Hoses. Comes with hoses MVHA-5, MVHA-10, MV-412HA, MV-HA33.
 8992515911	2 b Connector for Air + Electric Hoses with threads. This adapter is close to the dust extractor, where the pneumatic hose/electrical cable comes out. Comes with hoses MVHA-5, MVHA-10, MV-412HA, MV-HA33.
 8992515611	3 Hose adapter Ø 32 mm / 54 mm for Mirka® Dust Extractors. Comes with hoses MVHA-5, MVHA-10, MV-412HA, MV-HA33. This adapter goes from the hose into the dust extractor.
 8992515411	4 Soft Connector Ø 25,4 mm. Delivered together with hose MIN6519411. For connecting the hose to the Mirka Deco Sander.
 MV-HC32	5 Hose Connector Ø 32 / 32 mm. Delivered together with extension hose MIN6519711. Enables connection with the hose MIN6519411.
 839111211	6 Quick -disconnect air inlet for Hand Blocks. Comes with hose 91100-A